



FORTE BATTERY

LITHIUM THIONYL CHLORIDE BATTERY

高温锂亚电池 | 型号: ER18505S

Characteristics 性能数据

Nominal capacity(15mA-2.0v-150°C).....2800mAh

标称容量

Nominal voltage.....3.6v

额定电压

Max.constant current.....100mA

最大连续工作电流

Max.pulse current.....150mA

最大脉冲电流

Weight.....30g

电池重量

Volume.....Φ 18.5X50.5mm

电池尺寸

Workable temperature.....-40°C~+150°C

工作温度

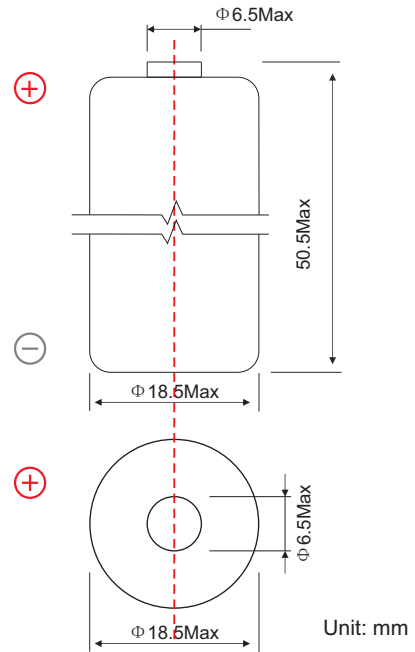

极端样式可按照客户要求定做

150°C放电曲线

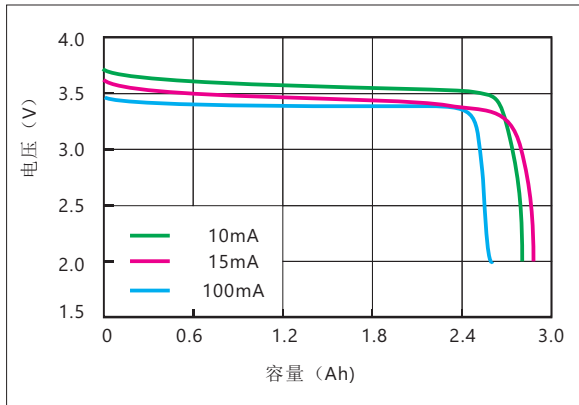

容量与温度关系曲线 (2.0V终止)

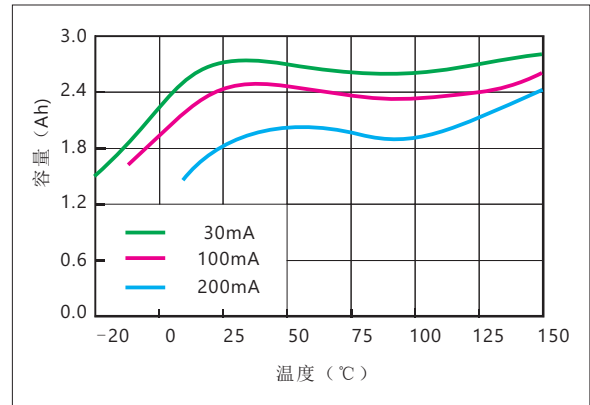

免责声明: 文中数据仅供参考, 不作电池性能的担保, 正式产品质量于购货合同中由供需双方确认

地址: 中国湖北武汉东西湖区吴家山台商投资区机电工业园

Add: Wujiashan Taiwan Businessmen Investment Zone, Wuhan, Hubei, China

P.C: 430040

Tel: 86-27-83258996

Fax: 86-27-83259120

E-mail: export@whforte.com

Http://www.whforte.com